



Multi-Currency 2-CIS Value Counter

User Manual



Preface

Thank you for purchasing the multi-currency value counter. We recommend reading all information in the user guide to become familiar with this product to ensure optimize the cash processing high efficiency when using the machine, fully understand the safety information and operation sequence, please keep the manual properly for future reference.

Content









- 1. General Introduction 1
- 2. Box Contents 1
- 3. Safety Precautions 2
- 4. Features 2
- 5. Specifications 3
- 6. Machine Overview 3
- 7. Getting Started 5
- 8. Function Keys and Touch Display 6
- 9. Operating Modes and Functions 8
- 10. User Menu 10
- 11. Adjusting Feeding Gap 14
- 12. CIS Calibration 16
- 13. Software Upgrade 18
- 14. Collecting Image Data 19
- 15. Error Messages 20
- 16. Maintenance 21

1. General Introduction

The machine is the perfect solution for a fast, accurate and reliable banknote counting process. It has a convenient user-friendly interface, touch screen and a variety of counting modes. All of these features come with a strong built-in counterfeit detection and high level of performance. This machine makes an invaluable aid in banks, casinos, supermarkets, movie theaters, retail shops and many other environments where banknotes are used.

2. Box Contents

When opening the box, verify that all of the items described below are included. If any item is damaged or missing, contact the dealer where the unit was purchased.

Item Name	Picture	Quantity (pcs)	Description
Banknote Counter		1	Mixed denomination Banknote counter
External Display		1	External LED display screen with RJ11 cable
Power Cable		1	Power supply cable
Banknote Guiders		2	Install at the hopper
CIS Calibration Paper		1	Used for the CIS calibration
Nylon Brush		1	Clean the machine
Soft cleaning Cloth		1	Clean the CIS or the other sensors
Fuse		1	The backup fuse for the power protection
User Manual		1	

3. Safety Precautions

When using this product, basic safety precautions should always be followed to reduce the risk of fire, electric shock or injury to persons, including the following:

WARNING

- Place the machine on a flat and stable surface.
- Do not place the machine in dusty or dirty environments.
- Do not place the machine in direct sunlight or near heat sources.
- Always disconnect the power cord before performing maintenance on the machine.
- Always connect the machine to an earthed socket outlet.
- Use only the supplied power cord.
- Operation temperature 15-35 °C / 59-95 °F.
- Operation humidity 30-80% R.H.
- Do not use the machine outdoors.
- Do not expose the machine to liquids.
- This machine contains rotating parts. Never touch the moving parts when the machine is switched ON.
- Keep jewellery, long hair, ties and other protruding parts away while operating the machine.
- Never disassemble the machine.
- This machine contains moving parts and sharp edges. Always be careful. Do not touch the components inside the machine while it is running.
- Please be careful to avoid any foreign objects, such as coins or staples, falling into the unit, as it may cause damage to the machine.

4. Features

- With UV, MG, MT, IR, CIS (image) detection
- With 4.5 inch touch screen
- With serial number recognition
- Multi-language interface
- Half-note, double-note, chain-note detection
- Auto currency identification and multi-currency mixed counting
- Denomination and version sorting function based on first banknote
- Add function, batch function, reporting and printing functions are available
- With USB interface, printer interface, external display interface
- Banknotes can be processed in all four orientations
- Easy software upgrade via USB port
- Suitable for most currencies in the world

5. Specifications

Hopper Capacity	Max. 500 notes
Stacker Capacity	Max. 200 notes
Feed System	Roller friction system
Counting Speed	800,1000,1200 notes/min 800,1000 notes/min for MDC & SDC mode
Dimension	240x265x280mm
Net Weight	6.5 kg
Gross Weight	7.5 kg
Power Supply	AC 100-240V 50/60Hz
Power Consumption	≤ 80W
Connection Port	USB, RS-232, RJ-11
Size of Countable Notes	50x110mm-90x190mm
Thickness of Countable Notes	0.08mm-0.12 mm
Operation temperature	15-35 °C
Operation humidity	30-80% R.H.

6. Machine Overview





7. Getting Started

7.1 Powering Up

- 1) Connect the power cable to the machine and the power outlet.
- 2) Press the Power Switch button to I to switch on.
- 3) After a short boot-up and self-test, machine enters the main menu.

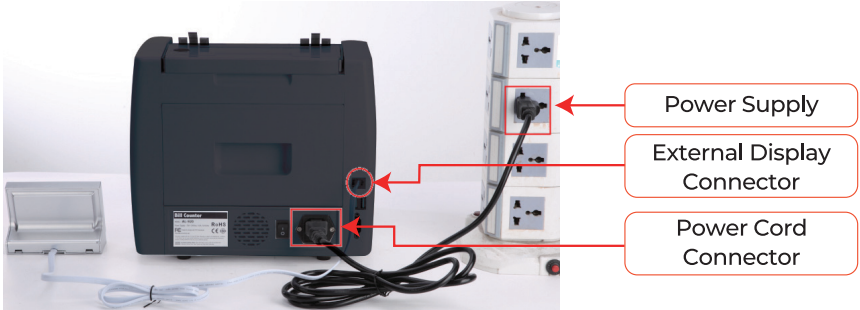

7.2 Banknote Guider Installation



7.3 Placing Banknotes

Avoid counting wet, excessively dirty or spoiled notes.

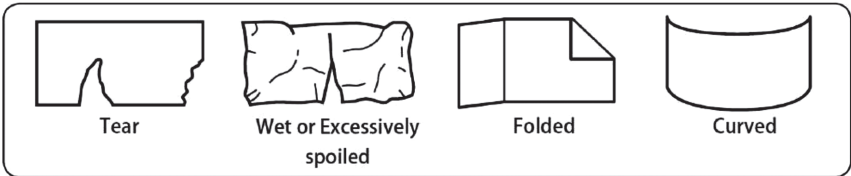

Check for foreign matter (paper chips, rubber bands, clips, dust etc.) mixed with notes.

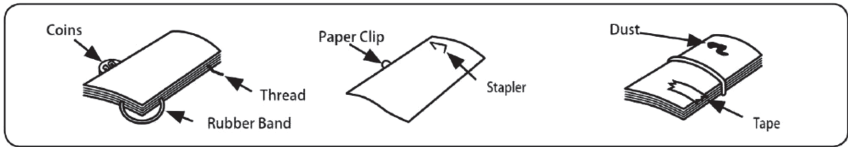

Remove folds or end from notes beforehand. Spread and separate brand new notes well for some of them are slightly adhesive.

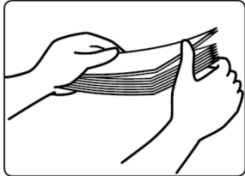

Set the banknote hopper guides so that the sides of the banknotes are enclosed. Organize your banknotes in a neat pile, make sure the backside of the pile is straight. Place the banknotes between the guides. The machine will automatically start counting.

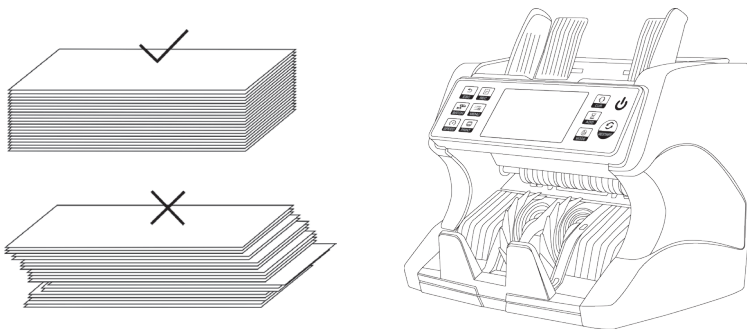

8. Function Keys and Touch Display

8.1 Function Keys Introduction

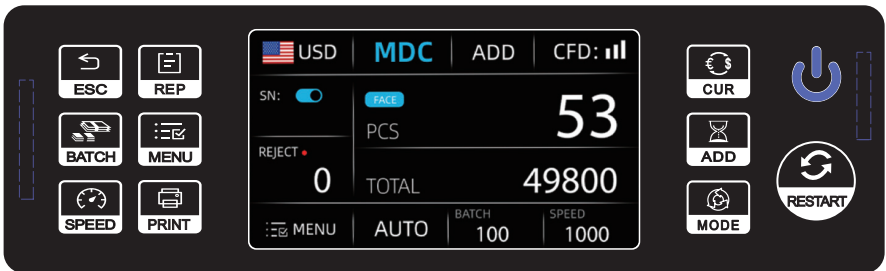



Press this key one time to check the detailed counted currency list, and then press again to check the serial number list when S/N reading function is ON.



Long press this key to enter the menu interface or press it to confirm the selection.



Press this key to print the receipt with count result if the machine connects to a printer.



Press this key to select the different available counting speeds.



Press this key to select the one of currency, auto recognition or multi-currency mode for counting.



Press this key to switch on/off the accumulative counting function.



Press this key to select counting mode from MDC(MIX), CNT(COUNT), SDC (SINGLE), SDCV (VERSION).



Press this key to set the batch number.



Press this key to return to the previous interface.



Press this key to start counting or clear counting result or save setting in menu.

8.2 User Interface and Touch Key

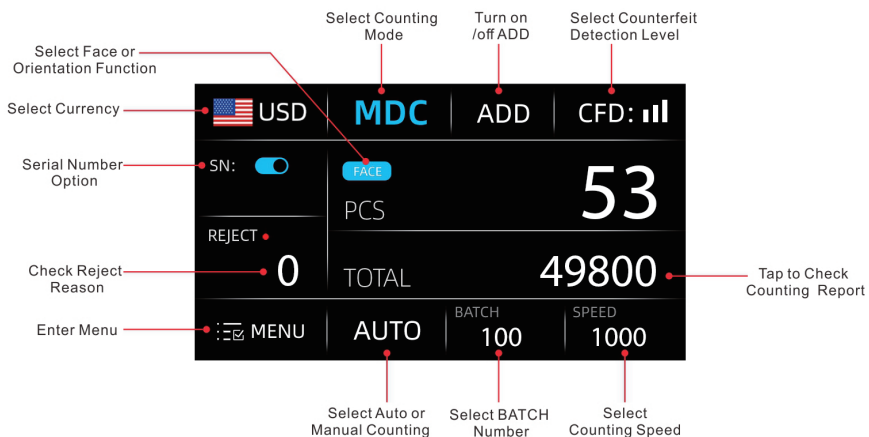

9. Operating Modes and Functions

9.1 Select Currency

Press  key or touch country flag  on screen to enter the currency selection, display will show AUTO, MULT and installed currencies, tap the one you need.

- **AUTO (Automatic Recognition Mode):** It allows the machine to recognize the currency automatically according to the first banknote. When detect other currency, the machine will alarm and stop, take out the banknote and press START key to continue counting. Please note that the machine can only recognize all of the currencies displayed in the currency selection interface.

- **MULT (Multi-currency Counting Mode):** It allows the machine to count mixed currencies, display will show total pieces and total value of each currency after counting. Please note that the machine only can recognize the first 4 currencies displayed on the currency selection interface.

Note: Only MDC mode is effective in the Multi-currency mode.

9.2 Counting Modes

9.2.1 MDC (Mixed Denomination Counting) Mode

MDC mode allows the user to count mixed denominations of banknotes, when the counting is completed, the total value and total number of banknotes are displayed on screen, the user can view a detailed report by pressing the REP key or tapping the total amount position on screen.

9.2.2 SDC (Single Denomination Counting) Mode

SDC mode allows the user to count and sort bills by one denomination which is automatically determined by the first bill scanned in the stack. This can be useful to be sure that there are no bills of other denominations in a large strap of one denomination. The first bill in the hopper determines the counting and sorting denomination. Any time a bill passes through the machine and does not conform to the denomination determined by the first bill, the machine will stop counting and alarm, take out the suspicious bill and press START key to continue counting. Total number of bills and total value will be displayed on home screen. When operation is complete, you can view a detailed report by pressing the REP key or tapping the total amount position on screen.

9.2.3 SDCV (Version Sorting) Mode

SDCV mode allows the user to count and sort bills by one version which is automatically determined by the first bill scanned in the stack. This can be useful to be sure that there are no bills of other versions in a large strap of one version. The first bill in the hopper determines the counting and sorting version. Any time a bill passes through the machine and does not conform to the version determined by the first bill, the machine will stop counting and alarm, take out the suspicious bill and press START key to continue counting. Total number of bills and total value will be displayed on home screen. When operation is complete, you can view a detailed report by pressing the REP key or tapping the total amount position on screen.

9.2.4 CNT (Piece Counting) Mode

COUNT mode allows the user to simply count the total number of bills. It does not recognize or record the denomination of any bills. During CNT mode, there is no counterfeit detection active.

9.2.5 Automatic / Manual Counting Mode

After turning the machine on it will default to automatic counting mode, an "AUTO" will be displayed on the home screen. In this mode the machine starts counting automatically. To operate with the manual counting mode, by tapping "AUTO" on screen switch to "MANUAL". In this mode, the machine will stop counting automatically, the "START" button must be pressed to begin each count.

9.3 Batch Function

Batch function is used to select a batch quantity for a specific counting process. With the BATCH mode active, the machine counts a preset number of bills and then stops counting when the batch number has been reached, even if bills remain in the hopper. When the banknotes are removed from stacker, the machine will automatically continue to count up to the preset batch number to create another batch.

9.4 Add Function

ADD function is used to add the counting results of multiple counts to the total. When ADD mode is activated, an ADD icon will be displayed on the home screen. To exit ADD mode, press again the ADD button or tap the ADD icon on screen.

9.5 Batch + Add Function

This function batches the desired quantity of bills and monitors the running total at the same time.

9.6 Serial Number Reading Function

The serial number reading function records the unique serial numbers of the counted banknotes. Serial number reading function is only available for some specific currencies such as USD, EUR, GBP, RUB, CNY, TRL, IDR, etc.

10. User Menu

Press MENU button or tap MENU on screen to enter the menu interface, as shown in the following figure.

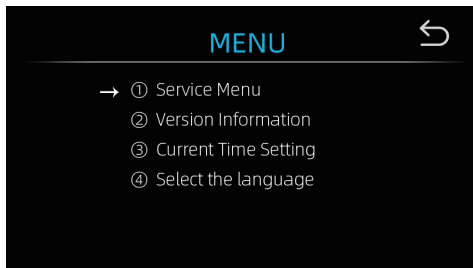

10.1 Service Menu

If you want to enter service menu, you will be requested to input a password with the following interface. The default password is 9999.

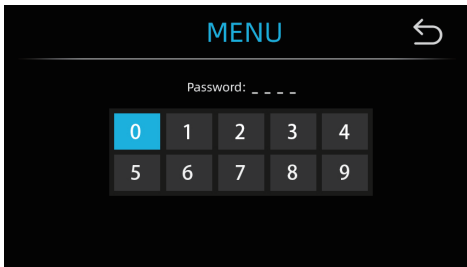

After input the password 9999, the interface will switch to the following one:

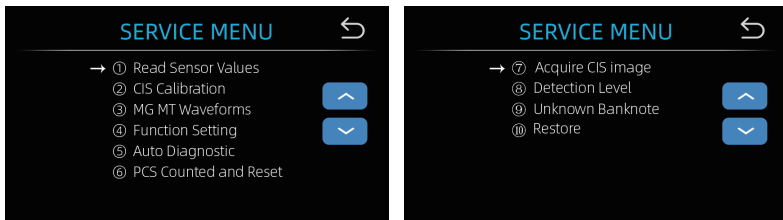

Tap the sub-menu you want to enter and tap return icon to go back.

10.1.1 Read Sensor Values

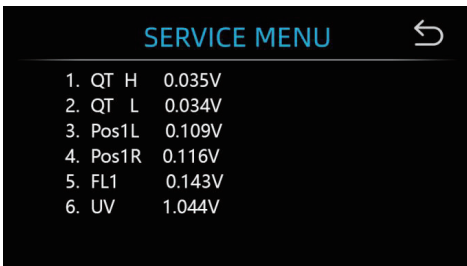

As shown in above figure, the sensors values are only for engineer to check whether any sensor has a malfunction. If you meet any problem about use, please take a photo of this page and contact the seller.

10.1.2 CIS Calibration

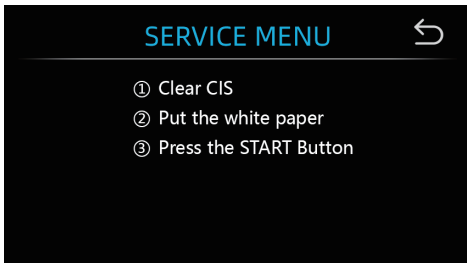

The contact image sensor (CIS) of the machine is calibrated properly from the factory. With regular and basic use, the sensor's sensitivity decreases which can lead to image errors. To resolve the issue, the machine can be re-calibrated using the white calibration paper that came with the machine.

10.1.3 MG MT Waveforms

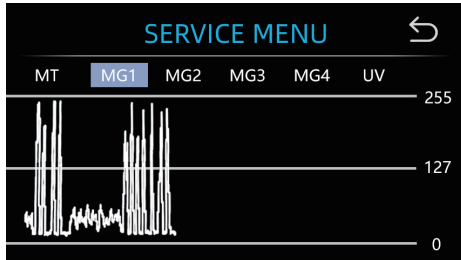

10.1.4 Function Setting

Setting	Toggle	Navigation
1. key beep	Off	Up
2. Warning beep	On	Up
3. Batch no clear	On	Down
→ 4. PC terminal	On	Down
5. RJ old ver. USD	On	None
6. Printer baud rate	9600	None

Setting	Value/Toggle	Navigation
→ 7. Paper width	58mm	Up
8. Cut paper CMD	0	Down
9. Err counted in	On	None
10. Cut paper after print	On	None
11. print reject detail	On	None

10.1.5 Auto Diagnostic

This is for production and professional servicing purpose.

10.1.6 PCS Counted and Reset

If select "PCS Counted and Reset" you will see the following interface. This interface is to tell the total quantity of counted bills in this counter since last clearing to zero.

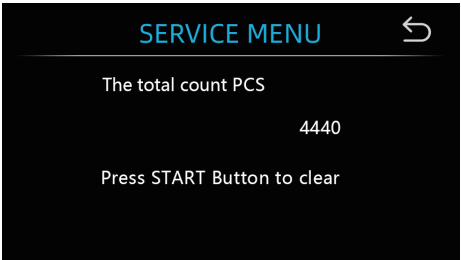

10.1.7 Acquire CIS Image

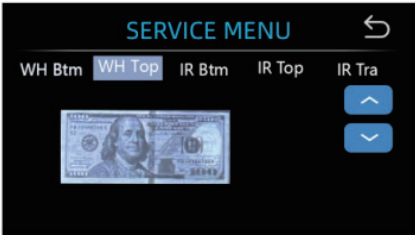

10.1.8 Detection Level

Please do not change the sensitivity levels without communicating with your local distributor.

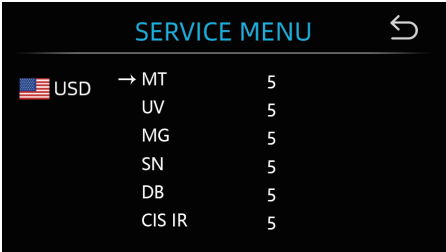

10.1.9 Restore

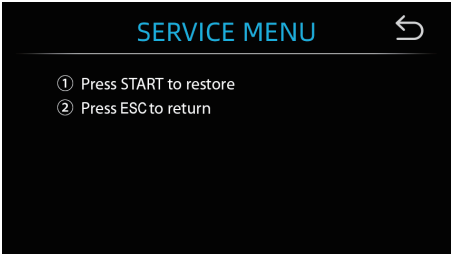

10.2 Version Information



10.3 Current Time Setting

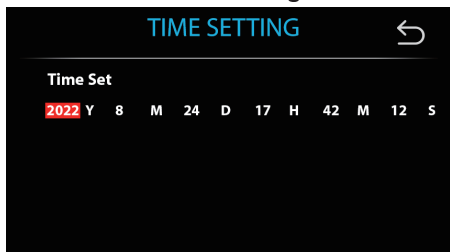

10.4 Select The Language

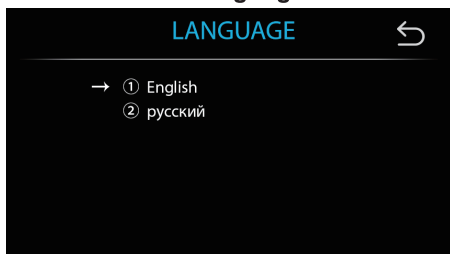

11. Adjusting Feeding Gap

When counting errors such as double notes, chained or slant notes occur frequently, or when banknotes are not being fed smoothly through the machine, it may be necessary to adjust the hopper adjusting screw. In the factory, the position of the hopper wheel is set optimal. However, sometimes during the transportation of the unit, the adjustment of the feed mechanism may loosen, and due to the nature of some banknotes, an adjustment may be required to ensure optimal feeding.

- When the banknotes are not being counted smoothly: increase the gap between the resistance wheel and the banknote twiddling wheel gear by turning the adjusting screw clockwise (+).
- When counting errors such as 'double notes' or 'chained notes' occur often, decrease the gap by turning the adjusting screw anti-clockwise (-)



Decrease the gap



Increase the gap

ATTENTION: Make only minor changes at once. Make Changes per dot or half a dot.

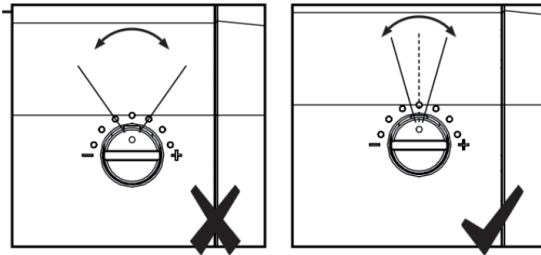

Please fine tune the feeding gap by the following steps.

- (1) Stop the auto counting first.
- (2) Insert one banknote to the gap between the rollers to check if the banknote can be inserted smoothly, as shown in the following.

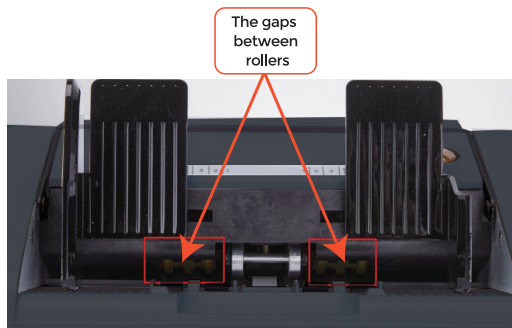

(3) If the banknote is hard to inserted, that means the feeding gap is too small, please rotate the screw clockwise until the banknote can be inserted smoothly. If the feeding gap is so large that two or more banknotes can be inserted to the feeding gap, please rotate the screw counterclockwise until the gap can just allow one banknote inserted.

(4) Use the banknote to check the other sides of the gap between rollers, to make sure the banknote can be inserted into both sides of the feeding gap smoothly.



One Coin to Rotate the Screw

Tips: you can just use one coin to rotate the screw.

12. CIS Calibration

CIS calibration is needed when there are many errors during the banknote counting process.

(1) Please enter the menu interface. And go to the service menu with the password "9999", as shown in the following figures.

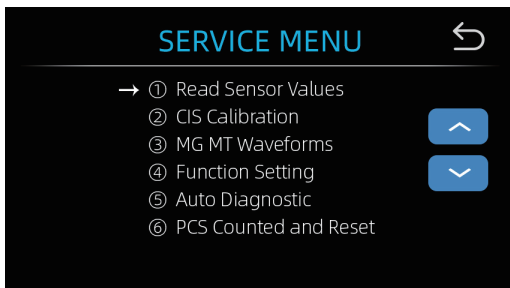
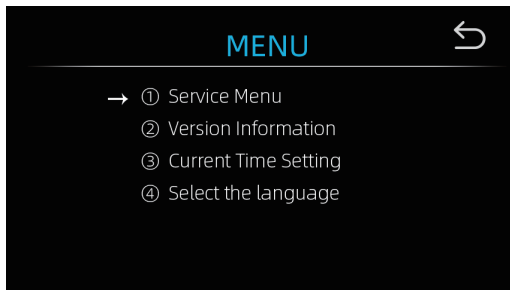

(2) Tap the "CIS Calibration" option, the screen will be shown in the following figure.

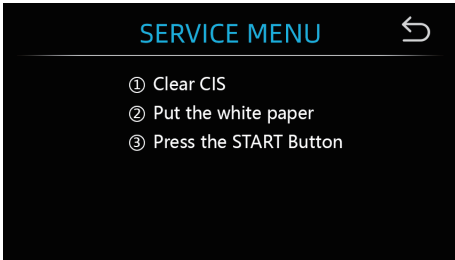

(3) Open the back cover to clean the CIS sensors with cleaning cloth.



Open the Back Covers



Clean the Lower CIS



Clean the Upper CIS

(4) Put the CIS calibration paper (white paper) inside, and close the back cover.



(5) Start CIS calibration by pressing the "START" button.

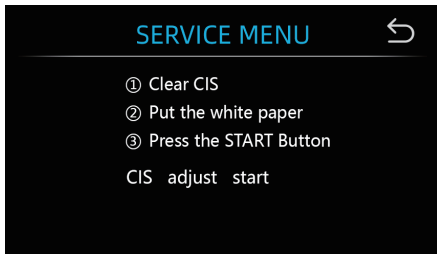

(6)After adjust succeed, just take the calibration paper out and close the back cover, and then turn off the machine.

(7)Turn on the machine to finish the CIS calibration.

13. Software Upgrade

U-disk upgrade method is adopted for the software upgrade of this machine. Please upgrade the software according to the following steps:

(1) The upgrade file needs to be moved to the root directory of the U-disk. (please do not change the file name or format of the upgrade file, and there cannot be two or more upgrade files in the root directory of the U-disk)

(2) Insert the U-disk into the USB interface at the rear of the machine. Make sure the power is off before insert the U-disk.

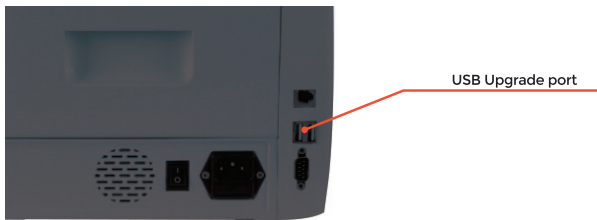

(3) Turn on the counter, and the machine will automatically recognize the upgrade file. Upon successful recognition, the machine will read the file first

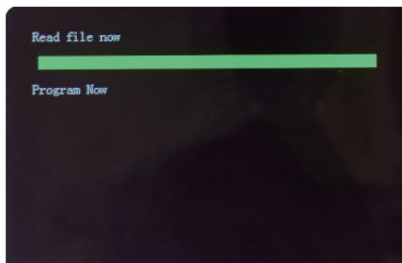

(4) And program the file to the counter.

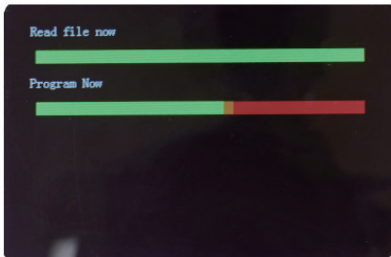

(5) After finish the programming, unplug the U-disk and restart the machine.

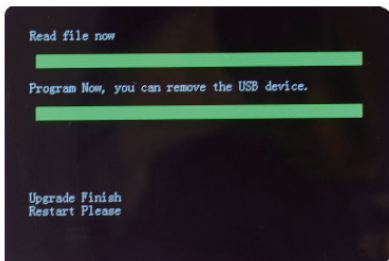

14. Collecting Image Data

14.1 Collect Fake Note or New Version Note Data

- (1) Insert U-disk to the USB port at the back of machine and display will show USB icon.
- (2) Select currency, then press MODE button to select CNT and set speed at 800.
- (3) Count four directions of the fake notes, the machine will save data automatically to the U-disk with a file.

14.2 Collect Original Note Error Data

- (1) Insert U-disk to the USB port at the back of machine and display will show USB icon.
- (2) Select currency, then press MODE button to select MDC and set speed at 800.
- (3) Count four directions of the notes, the machine will save data automatically to the U-disk with a file.

15. Error Messages

The machine will perform a self-test when turned on. Most of the following messages are caused by a sensor blocked by banknotes or dust. Remove the stuck banknotes, or use a brush or a piece of soft cloth to clean the dust off the sensor, and restart the machine.

Error Code	Error Message	Solutions
E1	UV Fault	Remove the banknote, clean the UV sensor.
E2	Double Notes	If the errors occur frequently, adjust the adjusting screw toward the anti-clockwise to decrease the gap.
E3	Chained Notes	
E4	Half Note	Remove the banknote.
E10	Image Error	Remove the banknote, clean the CIS sensor; Perform the CIS sensor calibration; Collect data of the banknote.
E11-E12	Denomination Error	
E13	Face Recognition Error	
E14	Size Recognition Error	
E15	Orientation Recognition Error	
E20	MT Error	Remove the banknote, clean or replace the MG sensors
E21	MG1 Error	
E22	MG2 Error	
E23	MG3 Error	
E24	MG4 Error	
E30	IR transmission area 1 error	Remove the banknote, clean the CIS sensor; Perform the CIS sensor calibration; Collect data of the banknote.
E31	IR transmission area 2 error	
E32	IR transmission area 3 error	
E33	IR transmission area 4 error	
E34	IR transmission area 5 error	
E35	IR transmission area 6 error	
E36	IR transmission area 7 error	
E37	IR transmission area 8 error	
E38	IR reflect area 1 error	

16. Maintenance

ATTENTION: The unit should always be turned off and disconnected from its power cord before cleaning. DO NOT use solvents such as thinner, alcohol, etc. to clean the machine.

Most operational problems can be avoided by regular care and preventative maintenance. Taking regular care of the machine will significantly increase its lifetime.

To avoid problems, make sure there are no metal clips or rubber bands in the bills being counted. Be sure to follow the proper procedure for loading the hopper.

For best results, it is recommended that to use an air duster and a soft bristle brush to remove any dust or debris from the interior of the unit. When not using the machine for an extended period time, cover it with a dust cover (not included with the unit) to prevent dust from settling inside.

All parts of the machine need daily care and cleaning. Pay close attention to the sensors, which are delicate components. If any dust or other foreign matter adheres to the sensors, it may cause various problems during operation of the machine.

- To avoid malfunction caused by foreign objects, please clean your machine every day.
- Open back cover and clean sensors with the provided bristle brush or a dry cloth frequently.
- Clean top cover and CIS with provided bristle brush or a dry cloth frequently.